

SigenStor Home

User Manual

Three-phase System

A1

Version: 04

Release date: 2024-09-27



Copyright© 2024 Sigenergy Technology Co., Ltd. All Rights Reserved.

Description in this document may contain predictive statements regarding financial and operating results, product portfolio, new technology, configurations and features of product. Several factors could cause difference between actual results and those expressed or implied in the predictive statements. Therefore, description in this document is provided for reference purpose only and constitutes neither an offer nor an acceptance. Sigenergy Technology Co., Ltd. may change the information at any time without notice.



SIGENERGY and other Sigenergy trademarks are owned by Sigenergy Technology Co., Ltd.

All trademarks and registered trademarks in this document belong to their owners.



Website

LinkedIn

YouTube

www.sigenergy.com

Contents

Revision History	4
Overview	5
Chapter 1 Safety Precautions	6
Chapter 2 Introduction to energy storage system	9
2.1 Product Introduction	9
2.2 Appearance Introduction.....	12
2.2.1 Appearance and Dimensions	12
2.2.2 Port Introduction	13
2.3 Label Description.....	14
2.4 Supported Power Supply Methods for the Power Grid	15
2.5 Introduction to Typical Networking.....	16
Chapter 3 Site Selection Requirements	23
Chapter 4 Equipment Installation and Wiring	26
Chapter 5 System Operation	27
5.1 Working Mode.....	27
5.2 LED Indicator State	31
5.3 mySigen App Query	33
Chapter 6 System Maintenance	34
6.1 Routine Maintenance	34
6.2 Equipment Powering-on/Power-off	35
6.3 Low SOC.....	37
6.4 Emergency Treatment	38
Chapter 7 Appendix	40
7.1 Technical Parameter	40

Revision History

Version	Date	Description
04	2024.09.27	Updated 2.1 Product Introduction Updated 2.5 Introduction to Typical Networking Updated 5.1 Working Mode Updated 6.1 Routine Maintenance Updated 6.2 Equipment Powering-on/Power-off
03	2024.05.31	Updated 2.5 Introduction to Typical Networking Updated Chapter 3 Site Selection Requirements Updated Chapter 4 Equipment Installation and Wiring
02	2024.04.19	Updated 2.3 Label Description Added 2.4 Supported Power Supply Methods for the Power Grid Updated 2.5 Introduction to Typical Networking Updated Chapter 3 Site Selection Requirements
01	2024.01.30	First official release.

Overview

Introduction



This document mainly introduces the product introduction, networking, system operation and maintenance of the devices in the SigenStor Home Three-phase system.

Readers

This document is suitable for product users and professionals

Sign Definition

The following signs may be used in the document to indicate security precautions or key information. Before installation, operation, and maintenance of the equipment, familiarize yourself with signs and their definitions.

Signs	Definition
 Danger	Danger. Failure to comply will result in death or serious personal injury.
 Warning	Warning. Failure to comply will result in serious personal injury or property damage.
 Caution	Caution. Failure to comply will result in property damage.
Tips	Important or key information, and supplementary operation tips.

Chapter 1 Safety Precautions

Basic Information

Before installation, operation, and maintenance of the equipment, familiarize yourself with this document.

The "Danger ", "Warning", "Caution" items described in this manual are only supplementary to all precautions.

The Company shall not be liable for equipment damage or property loss caused by the following reasons:

- Failure to obtain approval from the national, regional power authority.
- The installation environment does not meet international, national, or regional standards.
- Failure to observe local laws, regulations and norms when operating and maintaining equipment.
- The installation area does not meet the requirements of the equipment.
- Failure to follow the instructions and precautions in this document.
- Failure to follow the warning labels on equipment or tools.
- Negligent, improper operation or intentional damage.
- Battery capacity loss or irreversible damage caused by your failure to charge the device in time.
- Damage caused by your or a third party's replacement of our equipment (such as mixing our battery pack with other batteries, using our battery pack with other brands of inverters or converters, etc.).
- The equipment is damaged because of your or a third-party company fails to use the accessories supplied with the packing box or purchase and install accessories of the same specification.
- Equipment damage caused by improper operations such as disassembling, replacing, or modifying the software code without authorization.
- Equipment damage caused by force majeure (such as war, earthquake, fire, storm, lightning, flood, debris flow, etc.).

- Damage caused by the failure of the natural environment or external power parameters to meet the standard requirements of the equipment during actual operation (for example, the actual operating temperature of the equipment is too high or too low).
- The equipment was stolen.
- The equipment is damaged after the warranty period.

Safety Requirements

Danger

- An overheated battery pack may cause fire or explosion. Do not expose the device to high temperature or heat sources (such as fire, or heaters) around the equipment for a long time.
- Do not clean or soak the equipment with water, alcohol, or oil to avoid power leakage or battery pack leakage.
- Do not tipover or cause impact to the equipment. In case of an accident, please stop using the equipment immediately and contact your installer or sales representative, The equipment shall be inspected and evaluated by professional personnel before continuing to use.

Warning

- Do not touch the heat sink when the equipment is operating.
- When the equipment is operating, do not cover the decorative cover plate and keep the heat dissipation channel of 300–600 mm to avoid fire at high temperature.

 **Caution**

- Do not use the equipment if it has any defects. If the equipment appears abnormal (for example, battery pack leakage or appearance distortion), contact your installer or sales representative. It is prohibited to disassemble the equipment by yourself.
- Carbon dioxide fire extinguishers and ABC dry powder fire extinguishers are recommended at home.
- If the equipment cannot be charged, please contact your installer or sales representative in time.

Do not use the equipment in the following situations:

- When connected to public infrastructure systems.
- When connected to emergency medical equipment.
- When connected to elevators and other control devices.
- Any other critical systems.

Chapter 2 Introduction to energy storage system

2.1 Product Introduction

Inverter

Product code	Model No.	Name	Function specification
SigenStor EC	SigenStor EC 5.0 TP	Sigen Energy Controller 5.0 kW Three Phase	Inverter; it can be used in photovoltaic energy storage scenarios and needs to be used together with PV modules and SigenStor BAT.
	SigenStor EC 6.0 TP	Sigen Energy Controller 6.0 kW Three Phase	
	SigenStor EC 8.0 TP	Sigen Energy Controller 8.0 kW Three Phase	
	SigenStor EC 10.0 TP	Sigen Energy Controller 10.0 kW Three Phase	
	SigenStor EC 12.0 TP	Sigen Energy Controller 12.0 kW Three Phase	
	SigenStor EC 15.0 TP	Sigen Energy Controller 15.0 kW Three Phase	
	SigenStor EC 17.0 TP	Sigen Energy Controller 17.0 kW Three Phase	
	SigenStor EC 20.0 TP	Sigen Energy Controller 20.0 kW Three Phase	
	SigenStor EC 25.0 TP	Sigen Energy Controller 25.0 kW Three Phase	
	SigenStor EC 30.0 TP	Sigen Energy Controller 30.0 kW Three Phase	
SigenStor AC	SigenStor AC 5.0 TP	Sigen Storage Controller 5.0 kW Three Phase	Inverter; it can be used in pure storage scenarios and needs to be used with
	SigenStor AC 6.0 TP	Sigen Storage Controller 6.0 kW Three Phase	
	SigenStor AC 8.0 TP	Sigen Storage Controller 8.0 kW Three Phase	

	SigenStor AC 10.0 TP	Sigen Storage Controller 10.0 kW Three Phase	SigenStor BAT.
	SigenStor AC 12.0 TP	Sigen Storage Controller 12.0 kW Three Phase	
	SigenStor AC 15.0 TP	Sigen Storage Controller 15.0 kW Three Phase	
	SigenStor AC 17.0 TP	Sigen Storage Controller 17.0 kW Three Phase	
	SigenStor AC 20.0 TP	Sigen Storage Controller 20.0 kW Three Phase	
	SigenStor AC 25.0 TP	Sigen Storage Controller 25.0 kW Three Phase	
Sigen Hybrid	Sigen Hybrid 5.0 TP	Sigen Hybrid Inverter 5.0 kW Three Phase	Inverter; it can be used in conjunction with PV modules for pure PV applications or in combination with PV modules and SigenStor BAT for photovoltaic storage systems after the purchase and activation of a license.
	Sigen Hybrid 6.0 TP	Sigen Hybrid Inverter 6.0 kW Three Phase	
	Sigen Hybrid 8.0 TP	Sigen Hybrid Inverter 8.0 kW Three Phase	
	Sigen Hybrid 10.0 TP	Sigen Hybrid Inverter 10.0 kW Three Phase	
	Sigen Hybrid 12.0 TP	Sigen Hybrid Inverter 12.0 kW Three Phase	
	Sigen Hybrid 15.0 TP	Sigen Hybrid Inverter 15.0 kW Three Phase	
	Sigen Hybrid 17.0 TP	Sigen Hybrid Inverter 17.0 kW Three Phase	
	Sigen Hybrid 20.0 TP	Sigen Hybrid Inverter 20.0 kW Three Phase	
	Sigen Hybrid 25.0 TP	Sigen Hybrid Inverter 25.0 kW Three Phase	
	Sigen Hybrid 30.0 TP	Sigen Hybrid Inverter 25.0 kW Three Phase	

Battery Pack

Product code	Model No.	Name	Function specification
SigenStor BAT	SigenStor BAT 5.0	Sigen Battery 5 kWh	It can store electric energy.
	SigenStor BAT 8.0	Sigen Battery 8 kWh	

Power Sensor

Product code	Model No.	Name	Function specification
Power Sensor	Sigen Sensor TP-DH (SDM630MODBUS V2)	Sigen Power Sensor Three Phase DH	Data acquisition for grid connection points enables zero- power grid connection.
	Sigen Sensor TP-CT120-DH (SDM630MCT 40mA/120A)	Sigen Power Sensor Three Phase External CT 120 A DH	
	Sigen Sensor TP-CT300-DH (SDM630MCT 40mA/300A)	Sigen Power Sensor Three Phase External CT 300 A DH	
	Sigen Sensor TP-CT600-DH (SDM630MCT V2/600A)	Sigen Power Sensor Three Phase External CT 600 A DH	

Communication Module

Product code	Model No.	Name	Function specification
CommMod	Sigen CommMod	Sigen Communication Module	If it's used with our inverters, the communication between inverters and management systems should be realized through 4G.

2.2 Appearance Introduction

2.2.1 Appearance and Dimensions

Inverter and Battery Pack

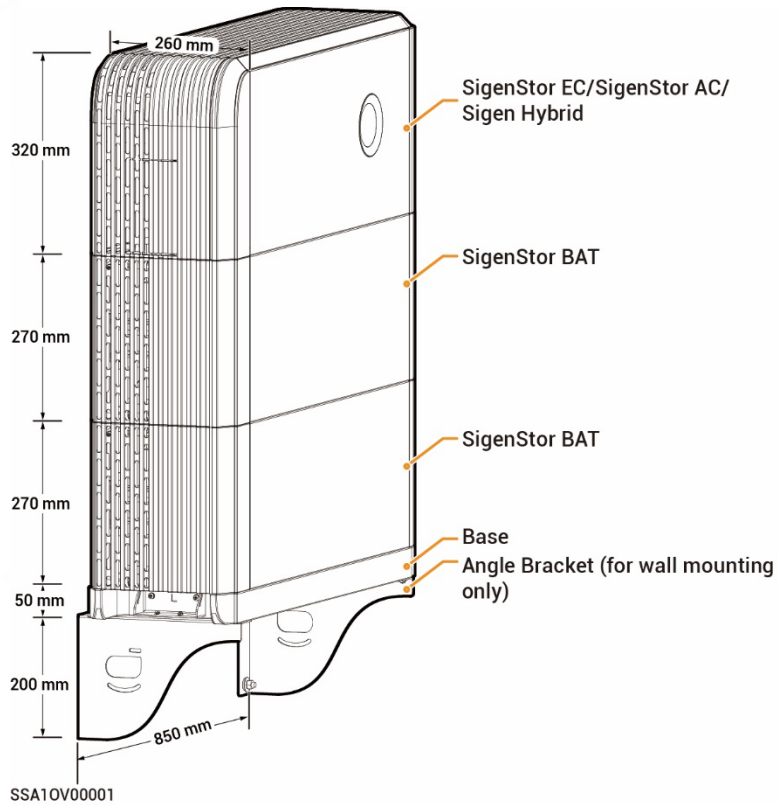

CommMod

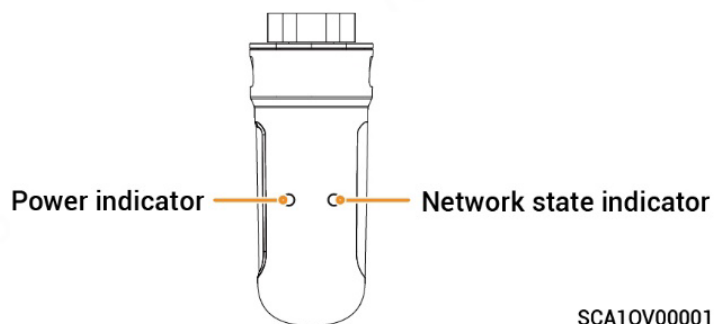





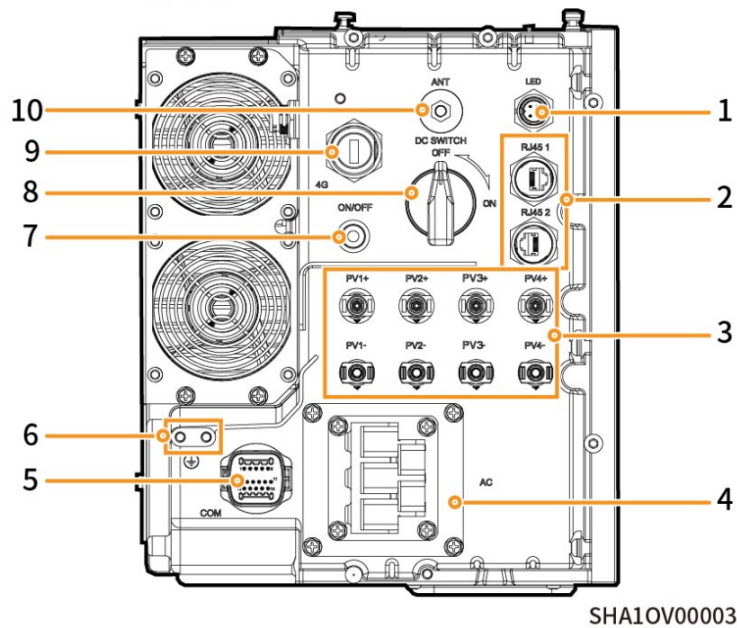

2.2.2 Port Introduction

SigenStor EC/ SigenStor AC/Sigen Hybrid Left View



S/N	Name	Marking
1	Decorative cover strip light connector	LED
2	Network interface	RJ45 1/ RJ45 2
3	DC input interface	PV1+/PV2+/ PV3+/PV4+/ PV1-/PV2- /PV3-/PV4-
4	AC output interface	AC
5	Communication interface	COM
6	Ground screw	-
7	Switch button	ON/OFF
8	DC switch	DC SWITCH
9	Sigen CommMod interface	4G
10	Antenna interface	ANT

2.3 Label Description

Symbols	Definition
	<p>Danger! High Voltage</p> <p>High voltage exists inside the equipment when powered on. Do not open the casing when the equipment is running. Any maintenance or servicing operations must be performed by trained and skilled electrical engineers.</p>
	<p>Warning! Life at risk.</p> <p>The equipment has potential hazards after running. Take proper protection when operating the equipment.</p>
	<p>After the equipment is powered off, the discharge of internal components is delayed. Wait 10 minutes until the equipment is fully discharged according to the label time.</p>
	<p>Warning! Risk of burns.</p> <p>The surface of the heat dissipation area is hot when the equipment is running. Do not touch it to avoid burns.</p>
	<p>Please refer to the instructions to operate the equipment.</p>
	<p>Earthing mark</p>

2.4 Supported Power Supply Methods for the Power Grid

- The grid supply methods supported include TN-S, TN-C, TN-C-S, TT and IT.
- When TT is used as the power supply technique for the power grid, the voltage between N and PE is required to be < 30 V.

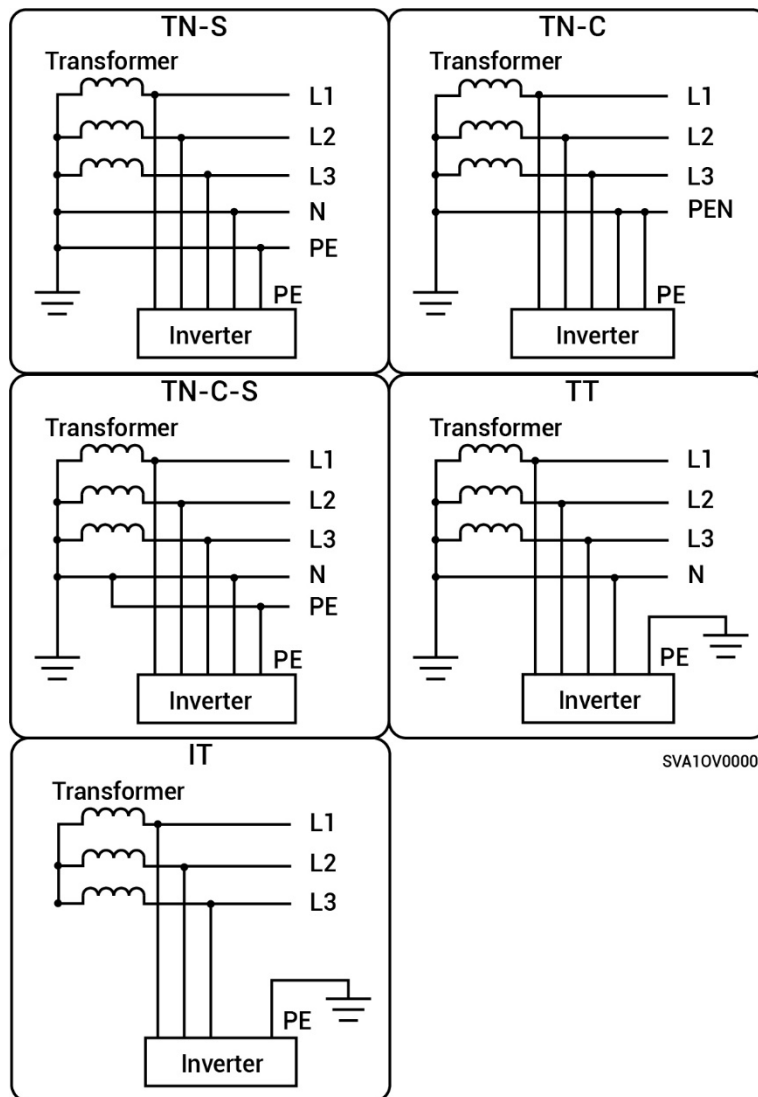

2.5 Introduction to Typical Networking

- Our company's products can be used for Home energy storage system. The Home energy storage system consists of photovoltaic panels, inverters, battery packs, master control switches, Gateway, loads, power grids, etc.
- The main function of Home energy storage system is to store the direct current generated by photovoltaic panels into battery packs. Or alternatively, the electricity in the photovoltaic system and the battery pack can be converted into alternating current for use by the load or incorporated into the grid.

Tips

Under backup power networking, the duration of off-grid operation of the backup power load is related to the power supply capacity of the PV storage system. If there is an abnormality in the power supply of the PV storage system during off-grid operation (including but not limited to abnormal PV power generation, insufficient battery power, and abnormal power supplies to the diesel generator), the backup power load will still be unable to operate.

Networking Diagram (Whole Home Backup)

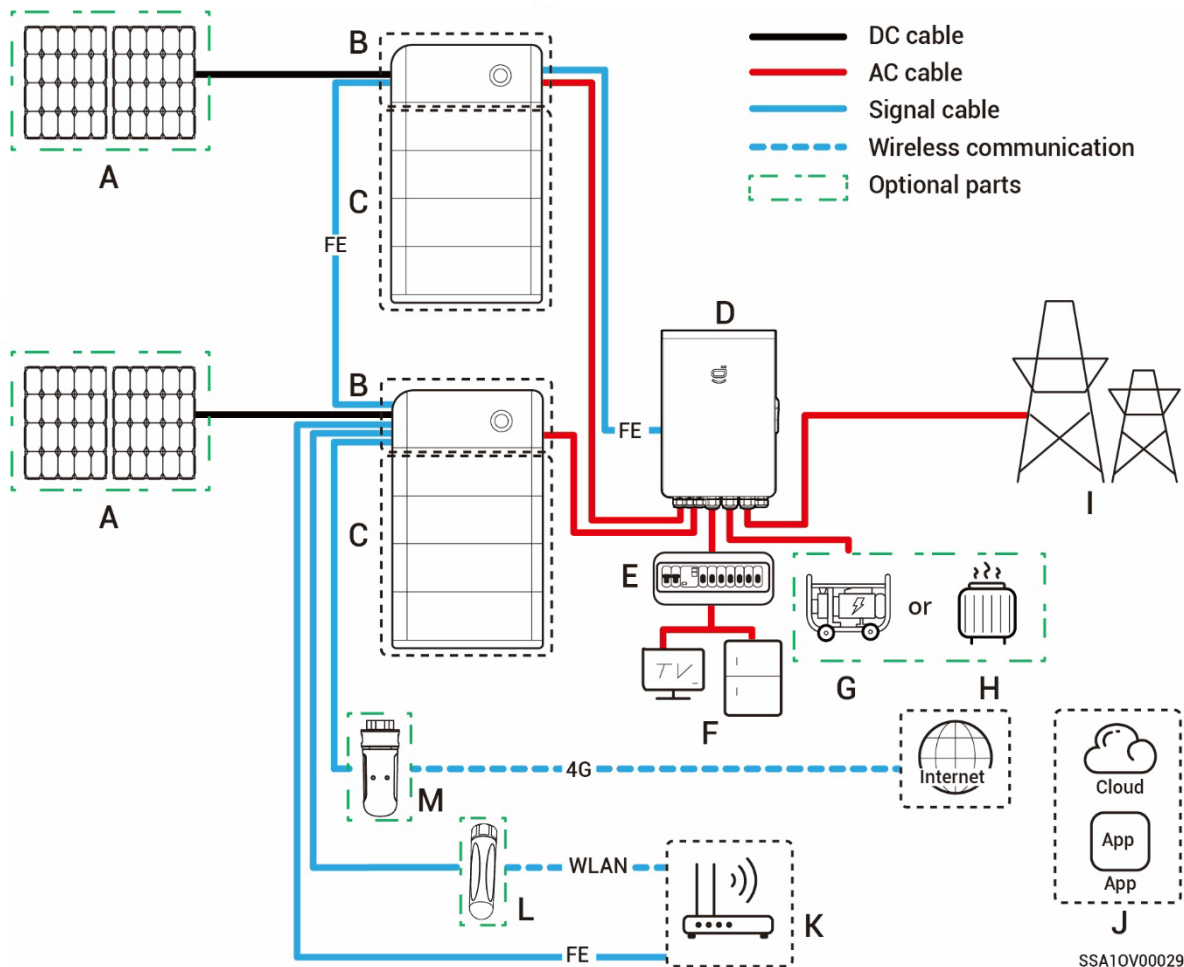

- A.** PV panel **B.** SigenStor EC/SigenStor AC /Sigen Hybrid
- C.** SigenStor BAT **D.** Gateway **E.** Backup Distribution panel
- F.** Backup Household loads **G.** Diesel generator **H.** Smart loads
- I.** Power grid **J.** mySigen **K.** Router **L.** Antenna **M.** CommMod

Tips

- When B is SigenStor AC, A is not configured.
- As a backup energy source for long-term off-grid applications, the diesel generator can work in tandem with the Gateway to provide a smooth transition between PV, storage and diesel generation.
- All the power equipment in the owner's home can be connected as smart loads. To ensure that this product maximizes the benefits to users, it is recommended that the high-power equipment be connected as smart loads (heat pumps, pool heaters, clothes dryers, etc.), which can be cut

off when the energy storage system has low power. Other low-power equipment are connected as household loads (lights, routers, etc.)

- It is recommended to use Fast Ethernet and WLAN for communication with inverters. When free 4G traffic of CommMod runs out, users must top up their accounts or replace a SIM card.

recommended that the high-power equipment be connected as smart loads (heat pumps, pool heaters, clothes dryers, etc.), which can be cut off when the energy storage system has low power. Other low-power equipment are connected as household loads (lights, routers, etc.)

- Power sensor has the function of data acquisition for grid connection points enables zero-power grid connection. For partial home backup, Power sensor does not need to be configured. For partial backup power and zero-power grid connection control networking, Power sensor is configured.
- It is recommended to use Fast Ethernet and WLAN for communication with inverters. When free 4G traffic of CommMod runs out, users must top up their accounts or replace an SIM card.

Networking Diagram (Non-backup Networking)

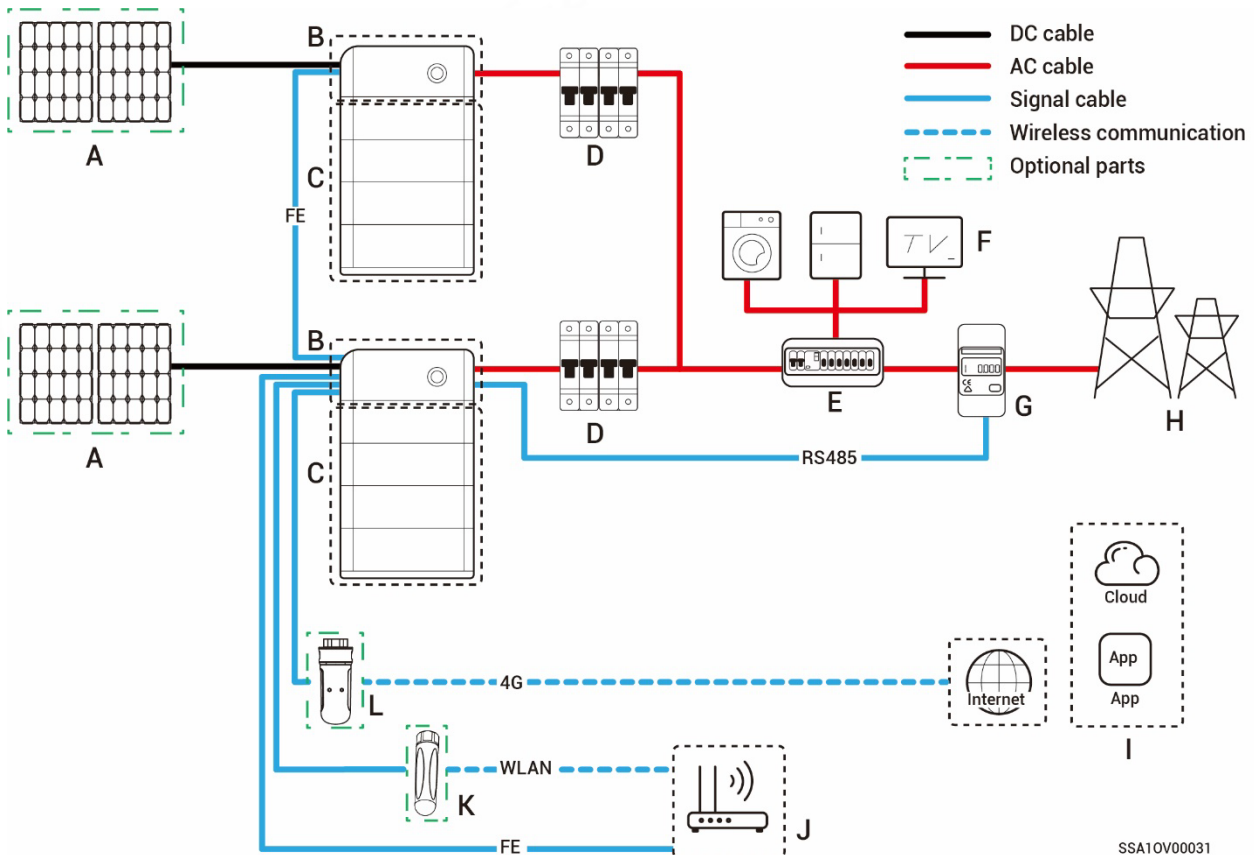

SSA10V00031

- A.** PV panel
- B.** SigenStor EC/ SigenStor AC/Sigen Hybrid
- C.** SigenStor BAT
- D.** AC switch
- E.** Distribution panel
- F.** Household loads
- G.** Power sensor
- H.** Power grid
- I.** mySigen
- J.** Router
- K.** Antenna
- L.** CommMod

Tips

- When B is SigenStor AC, A is not configured.
- When B is Sigen Hybrid, A is optional.
- The rated voltage of the AC switch connected to each inverter should be ≥ 380 V a.c., and the rated current is recommended:
 - SigenStor EC/SigenStor AC/Sigen Hybrid (5.0-8.0) TP: The rated current is 25 A
 - SigenStor EC/SigenStor AC/Sigen Hybrid (10.0-15.0) TP: The rated current is 32 A

- SigenStor EC/SigenStor AC/Sigen Hybrid (17.0-20.0) TP: The rated current is 40 A
- SigenStor EC/SigenStor AC/Sigen Hybrid 25.0 TP: The rated current is 50 A
- SigenStor EC/ Sigen Hybrid 30.0 TP: The rated current is 63 A
- It is recommended to use Fast Ethernet and WLAN for communication with inverters. When free 4G traffic of CommMod runs out, users must top up their accounts or replace an SIM card.
- The rated voltage of the AC switch of the distribution panel should be not less than 380 V a.c., and the rated current is recommended, that is, not less than the maximum output current of an inverter × the number of inverters in parallel connection × 1.25^[1].

Note [1]: The maximum output current of an inverter can be found in its respective data sheet.

Chapter 3 Site Selection Requirements

Tips

- The warranty applies when the equipment has been installed properly for its intended use and in accordance with the operating instructions.
- During actual installation, the selection of installation location should comply with local firefighting, environmental protection regulations, and other relevant laws. The specific installation location planning should be subject to the installer or engineering, procurement, and construction (EPC) contracts.

Installation Environment Requirements

- Do not install the equipment in smoky, flammable, or explosive environments.
- Avoid exposing the equipment to direct sunlight, rain, standing water, snow, or dust. Install the equipment in a sheltered place. Take preventive measures in operating areas prone to natural disasters such as floods, mudslides, earthquakes, and typhoons.
- Do not install the equipment in an environment with strong electromagnetic interference.
- Ensure that the temperature and humidity of the installation environment comply with the equipment's requirements.
- The equipment should be installed in an area that is at least 500 m away from corrosion sources that may result in salt damage or acid damage (corrosion sources include but are not limited to seaside, thermal power plants, chemical plants, smelters, coal plants, rubber plants, and electroplating plants).

Installation Position Requirements

- Do not tilt or overturn the equipment to ensure that it is installed horizontally.
- Do not install the equipment in places easily touched by children.

- Do not install the equipment in places with fire or damp.
- The equipment produces sound when it is operating. Please install the equipment in a place far away from your daily work and daily life.
- Do not install the equipment in a sealed, poorly ventilated location without fire protection measures and difficult access for firefighters.
- The equipment is hot when it is running. If the equipment is installed indoors, please ensure good indoor ventilation and avoid significant indoor temperature rise by 3°C while the equipment is running. Otherwise, the equipment will be derated.
- Do not install the equipment in mobile scenarios such as RVS, cruise ships, and trains.
- You are advised to install the equipment in a location where you can easily access, install, operate, maintain it, and view the indicator status.
- When installing the equipment in the garage, do not install the equipment in the position where the vehicle passes through to avoid collision.

Mounting Surface Requirements

- Do not install the equipment on a flammable installation base.
- The installation base should meet the load-bearing requirement. Solid brick-concrete structures, concrete walls, and floors are recommended.
- The surface of the installation base must be smooth and the installation area must meet the installation space requirements.
- No water or electricity is routed inside the installation base to prevent drilling hazards during equipment installation.

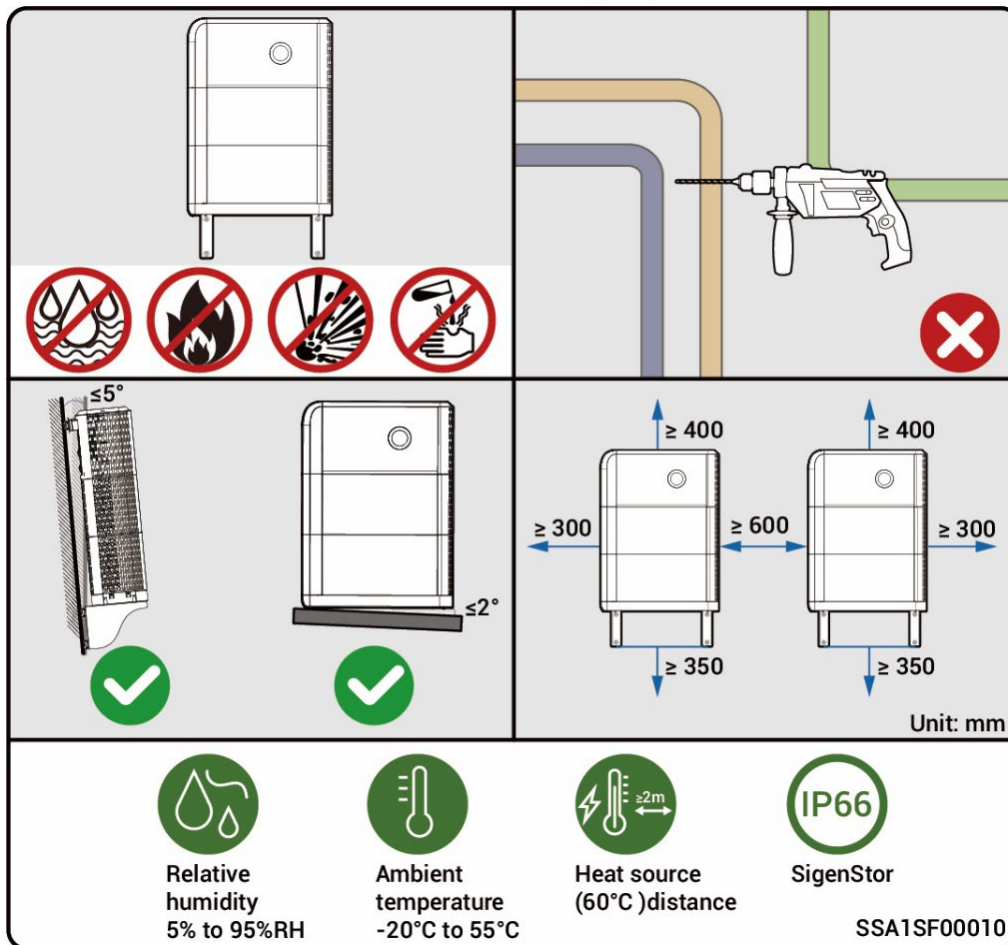

Tips

- The maximum operating temperature range applicable to the equipment is -20°C to 55°C , and the recommended optimal operating temperature range is $10^{\circ}\text{C} \leq T \leq 35^{\circ}\text{C}$.
- When the battery pack temperature is below 0°C , immediate charging is not possible, and the battery pack (the built-in heating module can be automatically enabled) will activate the heating feature automatically. The best charging performance of the battery can be achieved after heating for less than 2 h. The heating feature will consume power.
- At a temperature $> 40^{\circ}\text{C}$, the operation of the equipment may trigger a power derating that prevents the equipment from operating optimally. The higher the temperature, the shorter the service life of the equipment.

Chapter 4 Equipment Installation and Wiring

- Only company authorized personnel should install and connect the equipment. For details, see ***SigenStor Home Installation Guide - Three-phase System A1***.
- Parts and accessories supplied with the packing box are personal assets of the owner and must be kept safe.

Chapter 5 System Operation

5.1 Working Mode

Tips

- There are six operating modes of the energy storage system: Sigen AI Mode, Fully Fed to Grid Mode, Self-Consumption Mode, Time-based Control Mode, Remote EMS Mode, Load Shedding.
- Sigen AI Mode can be used in some countries, which is explicitly stated on the App interface.

Sigen AI Mode

By recording the peaks and troughs of users' consumption habits and local electricity prices for a period of time, Sigen AI mode can customize smart electricity solutions to maximize savings for customers.

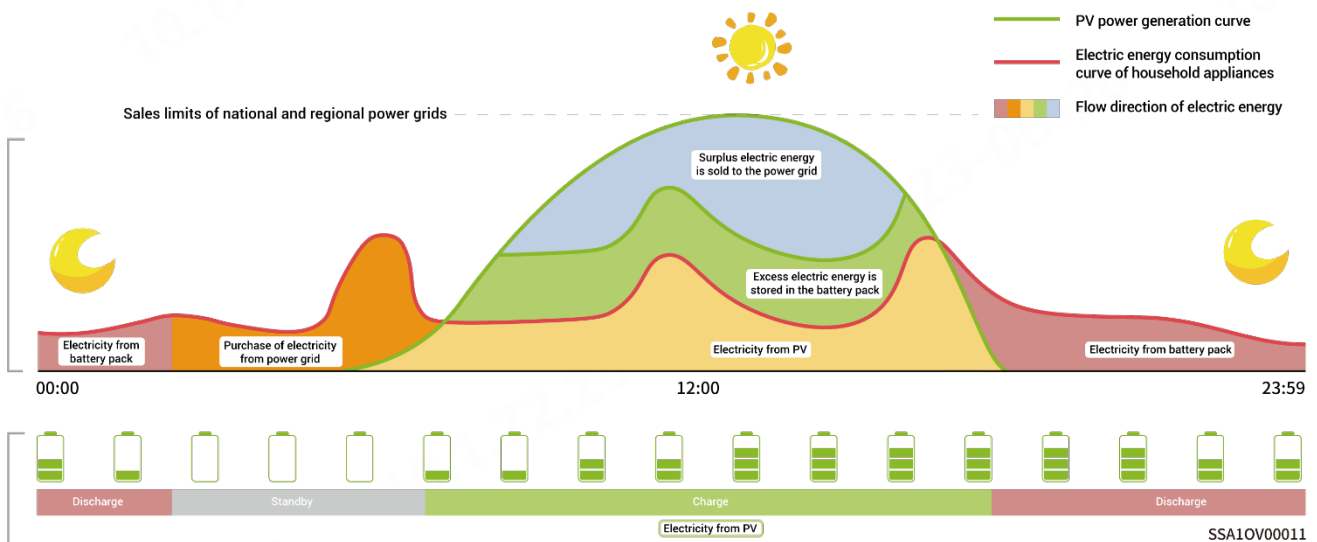

Fully Fed to Grid Mode

The PV power generation can be maximized for sale to the power grid. During the daytime when the PV-generated power is greater than maximum output capacity of the inverter, the inverter stays at maximum output while the excess electricity is stored in batteries; when the PV-generated power is lower than

maximum output capacity of the inverter or when no PV power is generated at night, the batteries are discharged to ensure that the inverter can maximize the output.

Self-Consumption Mode

When there is sufficient solar power, the electric energy generated by the PV system will first be used to power the loads, with any excess energy being stored in the batteries. If there is still surplus energy, it will flow into the power grid. When there is insufficient solar power, the batteries will release electric energy to loads. By increasing the self-consumption ratio of the PV system and improving the self-sufficiency ratio of household energy, you can effectively save on your electric bills.

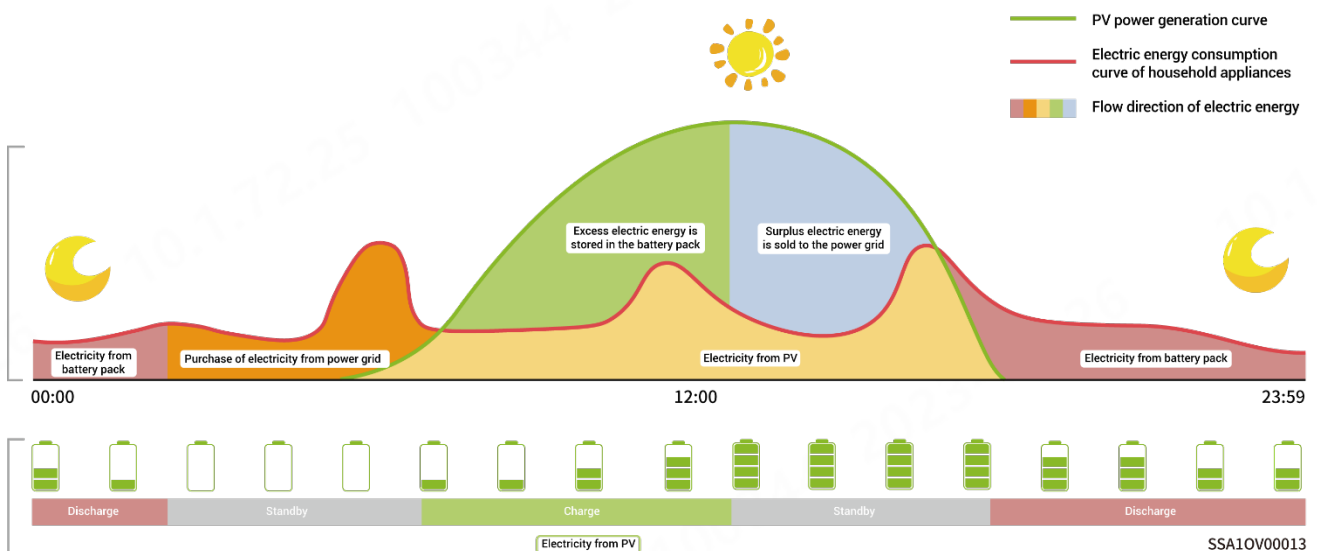

Time-based Control Mode

In Time-based Control Mode, the charging period and discharge period should be manually set in the mySigen App, and the other periods are non-charging and non-discharging ones. The surplus electricity generated by PV during the day can be sold to the grid or charged to the battery, and the battery can be charged at night during the period of low electricity price of the grid to save electricity costs.

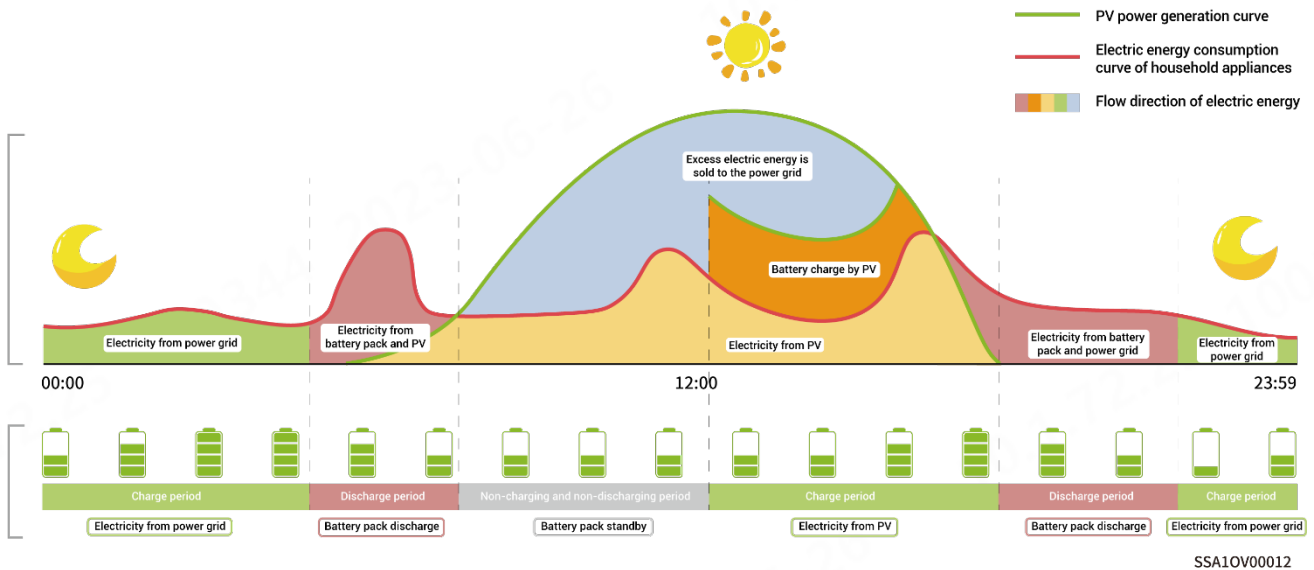

Remote EMS Mode

After setting to this mode, a third-party EMS dispatch company will be allowed to set the relevant parameters of the power station and products. Do not enter or exit this mode without the installer's confirmation.

Load Shedding

In areas with frequent power outages, you can add your region and schedule in this mode, and the system will fully charge the battery in advance as scheduled, ensuring that you have battery power available to supply the load during outages.

Backup Reserve:

If there is a Gateway in the network, you can manually set the "Backup Reserve" value in mySigen App. When the grid is connected, the battery stops discharging when the set backup SOC is reached; when the grid is powered down, the battery power from the backup can be used.



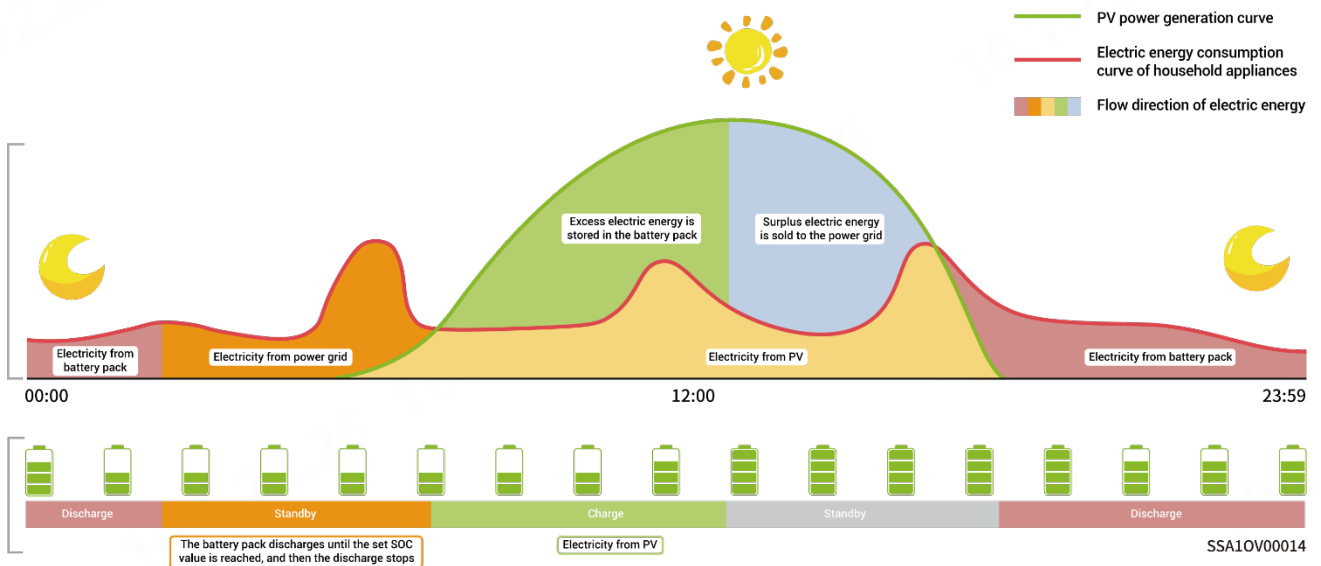





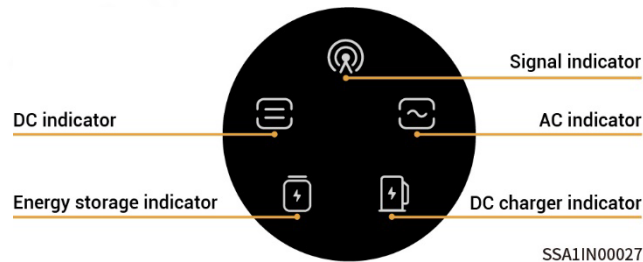











Example: Self-Consumption Mode involves backup SOC.









5.2 LED Indicator State

SigenStor EC/ SigenStor AC/Sigen Hybrid Indicator



Indicator	Color	State	Description
		Always on	The DC side is connected but not running.
		Always on	The DC side is running.
		-	The DC side is not connected.
		Flash	The DC side is faulty.
		Always on	Inverter failure.
		Always on	The AC side is connected but not running.
		Always on	Grid-connected operation.
		Always on	Off-grid operation.
		-	The AC side is not connected.
		Flash	Off-grid overload operation.
		Flash	The AC side is faulty.
		Always on	Inverter failure.
		Always on	All SigenStor BATs are connected but not running.
		Flash	SigenStor BAT is charging.
		Flash	SigenStor BAT is discharging.
		-	All SigenStor BATs lie dormant.
		Flash	Some SigenStor BATs are faulty.
		Always on	All SigenStor BATs are faulty.

Indicator	Color	State	Description
		Off	The management system is not connected.
		Flash	Connected to local App.
		Always on	Connected to the management system using an FE or WLAN.
		Always on	Connected to the management system over 4G.
		Flash	Insufficient traffic for Sigen CommMod.

CommMod Indicator

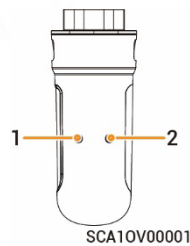

S/N	Name	State	Description
1	Power indicator	-	-
2	Network state indicator	Slow flashing (200 ms on/1800 ms off)	The network is being connected
		Slow flashing (1800 ms on/200 ms off)	Standby.
		Quick flashing (125 ms on/125 ms off)	Data is being transferred.

5.3 mySigen App Query

The App can be downloaded in the following two ways. For details, see **mySigen App User Manual**.

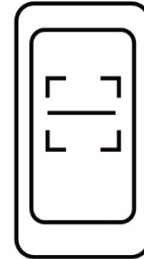

SSA1CM00014

Chapter 6 System Maintenance

6.1 Routine Maintenance

To ensure the long-term operating of the equipment, you are advised to perform routine maintenance according to this section.

Inspection content	Inspection method	Power off or not	Maintenance cycle
System cleaning	Regularly check whether the decorative cover or fan is covered and dirty. Clean it up when necessary. Do not use tools that may cause electric shock or with damaged insulation when cleaning up, such as wire brushes.	Yes	Once every three months.
System operating state	<ul style="list-style-type: none"> ● Check whether the equipment is damaged or deformed. ● Listen for any abnormal noises during the operation of the equipment. ● When the equipment is running, check whether the equipment parameters are correctly set. 	No	Once every six months.

6.2 Equipment Powering-on/Power-off

Scheme 1: App operation

In the mySigen app, tap "Settings" to turn the device on or off.

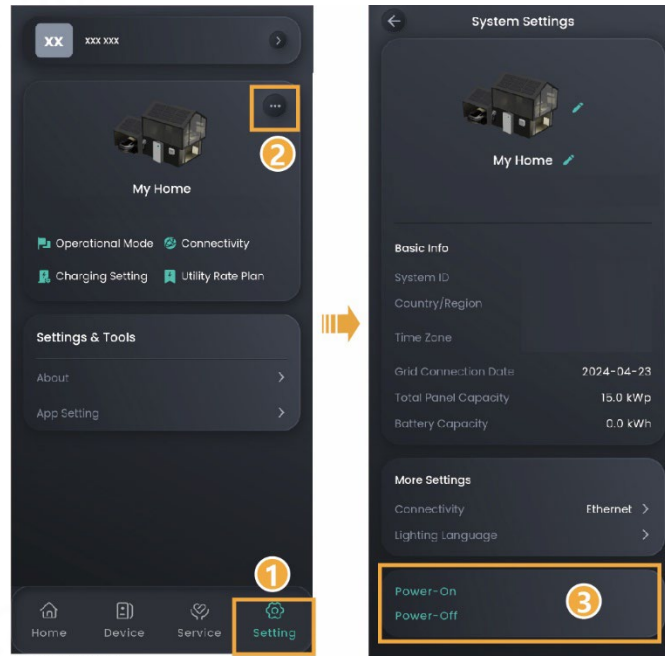

SSA1CM0001

Scheme 2: Manual operation

Follow the steps shown to remove the side and top decorative cover, and press the ON/OFF switch button.

Tips

Press and hold for more than 3s to turn on or off the power; an interval of more than 10s is needed between power-on and power-off.

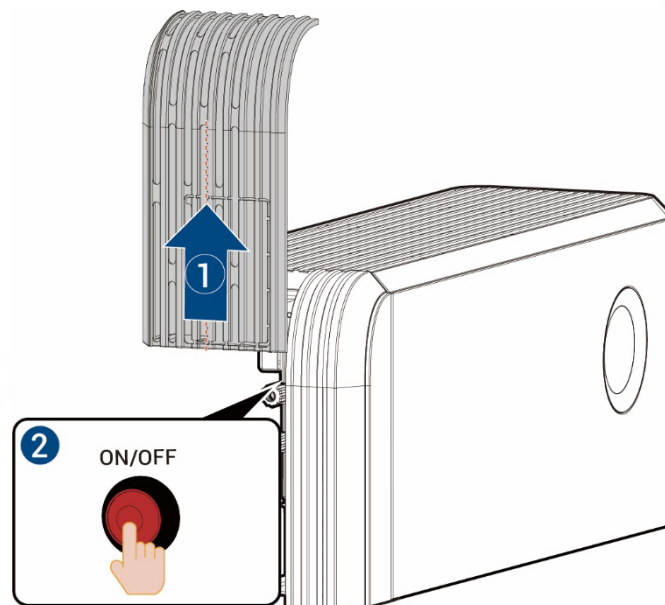

SSA1IN00030

Tips

Major firmware upgrades can fail if the equipment is not connected to the internet for an extended period of time. When your equipment is not connected to the internet, the system will send you a reminder repeatedly. If the system does not receive feedback from you for a long time, the system will operate under limited conditions for security reasons. If you want to make the equipment fully functional, connect the equipment to the internet. The system will automatically restore its functionality. If you have further questions, please contact us for assistance.

6.3 Low SOC

The self-discharge characteristic of battery pack will cause power loss. If the equipment is not charged for a long time, it may be damaged due to overdischarge of power. When the battery is low, charge the equipment in time. Under normal circumstances, the equipment can charge itself according to the running condition. If the equipment cannot be charged, please contact your sales agent in time and deal with it within the specified time. If the battery capacity is lost or irreversible damage is caused due to the delay, the company will not be liable.

- When the battery power is greater than or equal to 10%, charge within 30 days
- When the battery power is less than or equal to 0% and less than 10%, charge within 7 days

Scenarios that may cause a charge failure (including but not limited to) :

- The PV side has no input, and the power grid side is powered off for a long time.
- The equipment is faulty.
- Parameters are not set correctly.

6.4 Emergency Treatment

Emergency in case of Fire

 **Danger**

- Please shut down the equipment or disconnect the main power switch when it is safe.
- The high temperature may distort or damage the battery pack, resulting in electrolyte overflow or toxic gas leakage. Do not go near the battery pack and wear protective equipment.
- If the fire is small, use carbon dioxide or ABC dry powder extinguisher to extinguish the fire.
- If the fire is spreading, evacuate the building or equipment area immediately and call the fire department. Re-entry to burning buildings is prohibited.
- Do not touch or come into contact with high voltage components during fire fighting, due to the risk of electric shock.
- After extinguishing the fire, do not use the equipment, please contact your installer or sales representative.

Emergency in case of Flood

 **Danger**

- Please shut down the equipment or disconnect the main power switch when it is safe.
- If the battery pack is submerged, do not touch it to avoid the danger of electric shock.
- After the flood waters recede, do not use the equipment. Please contact your installer or sales representative.

Emergency in case of Battery Pack Malfunctions

Danger

- When the battery pack has abnormal odor, electrolyte leakage, or heat, do not touch it, and contact professional personnel immediately. Professionals must wear protective equipment such as goggles, rubber gloves, gas masks, and protective clothing to protect themselves.
- The electrolyte is corrosive and contact may cause skin irritation or chemical burns. In case of accidental contact with the electrolyte, take the following measures immediately:
 - Inhalation: Evacuate the contaminated area, keep fresh air circulating, and seek immediate medical help.
 - Eye contact: Flush eyes with plenty of water for at least 15 minutes. Do not rub eyes. Seek medical help immediately.
 - Skin contact: Wash the contact area with plenty of soapy water and seek medical help immediately.
 - Ingestion: Induce vomiting and seek medical help immediately.
- Do not continue to use abnormal battery packs, please contact your installer or sales representative.

Emergency in case of Battery Pack Drops or Impacts

- If there is an obvious odor, smoke, or fire, keep away from the equipment immediately and contact professional personnel.
- Do not use the battery pack if it has been dropped or hit. Please contact your installer or sales representative.

Chapter 7 Appendix

7.1 Technical Parameter

For details about equipment parameters, see the Data sheets of the product.